

YAMAHA TX-10

Natural Sound AM/FM Stereo Tuner

Syntonisateur AM/FM stéréo de la série "Natural Sound"

"Natural Sound" MW/UKW-Stereo-Tuner

Natural Sound AM/FM stereotuner

Sintonizzatore stereo AM/FM a suono naturale

Sintonizador estéreo de AM/FM de sonido natural

Natural Sound Stereo Tuner

OWNER'S MANUAL
MODE D'EMPLOI
BEDIENUNGSANLEITUNG
BRUKSANVISNING
MANUALE DI ISTRUZIONI
MANUAL DE INSTRUCCIONES
GEBRUIKSAANWIJZING

SUPPLIED ACCESSORIES
ACCESSOIRES FOURNIS
MITGELIEFERTE ZUBEHÖRTEILE
MEDFÖLJANDE TILLBEHÖR
ACCESSORI IN DOTAZIONE
ACCESORIOS INCLUIDOS
BIJGELEVERDE ACCESSOIRES

- After unpacking, check that the following parts are contained.
- Après le déballage, vérifiez que les pièces suivantes sont incluses.
- Nach dem Auspacken überprüfen, ob die folgenden Teile vorhanden sind.
- Kontrollera efter det apparaten packats upp att följande delar finns med.
- Verificare che tutte le parti seguenti siano contenute nell'imballaggio dell'apparecchio.
- Desembale el aparato y verificar que los siguientes accesorios están en la caja.
- Controleer na het uitpakken of de volgende onderdelen voorhanden zijn.

- Indoor FM Antenna
- Antenne FM intérieure
- UKW-Innenantenne
- FM inomhusantenn
- Antenna FM per interni
- Antena FM interior
- FM Binnenantenne

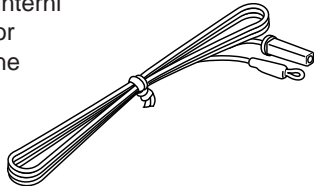

- AM Loop Antenna
- Cadre-antenna AM
- MW-Rahmenantenne
- AM ramantenn
- Antenna AM ad anello
- Antena de cuadro de AM
- AM Lusantenne

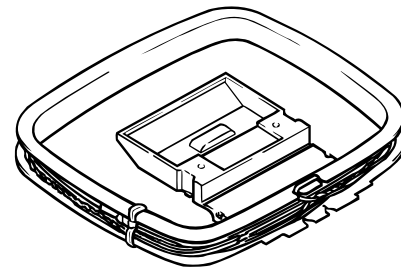

- Audio connection cord
- Câble de connexion audio
- Audio-Anschlußkabel
- Audio anslutningsladdar
- Cavo di collegamento audio
- Cable de conexión de audio
- Audio aansluitkabel

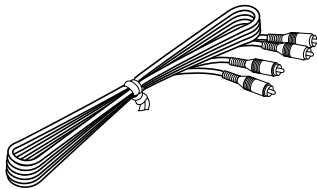

FEATURES

- 40 Station Random Access Preset Tuning
- Automatic Preset Tuning
- Multi-Status Station Memory
- Direct PLL Synthesizer Tuning
- Preset Station Shifting Capability
- Multi-Functions for RDS Broadcast Reception (U.K. and Europe models only)

CONTENTS

Supplied Accessories.....	2
Caution.....	3
Connections	4
Tuning Operations	7
Preset Tuning.....	9
Receiving RDS Stations (U.K. and Europe models only)	12
Troubleshooting	17
Specifications.....	18

CAUTION: READ THIS BEFORE OPERATING YOUR UNIT.

1. This unit is a sophisticated stereo tuner. To assure proper operation and the best possible performance, please read this manual carefully.
2. Choose the installation location for the unit carefully. Avoid placing it in direct sunlight or close to a source of heat. Also avoid locations subject to vibration and excessive dust, heat, cold or moisture. Keep it away from such sources of hum as transformers or motors.
3. Do not open the cabinet, because this may result in damage to the unit or electrical shock. If a foreign object should get into the unit, contact your local dealer.
4. When not planning to use this unit for long periods of time (ie., vacation, etc.), disconnect the AC power plug from the wall outlet.
5. To prevent lightning damage, disconnect the AC power plug and disconnect the antenna cable when there is an electrical storm.
6. When disconnecting the power plug from the wall outlet, always pull directly on the plug; never pull the cord itself.
7. Do not use force when operating switches and other controls.
8. When moving the unit, be sure to first disconnect the power plug and disconnect all wires connected from the unit to other equipment.
9. Do not attempt to clean this unit with chemical solvents, because this may damage the finish. Use a clean, dry cloth.
10. Be sure to read the "TROUBLESHOOTING" section of this manual for advice on common operating errors before concluding that the unit is faulty.
11. Keep this manual in a safe place for future reference.
12. **Voltage Selector (General Model only)**
The voltage selector on the rear panel of this unit must be set for your local main voltage BEFORE plugging into the AC main supply.
Voltages are 110-120/220-240V AC, 50/60 Hz.

IMPORTANT

Please record the serial number of this unit in the space below.

Serial No.:

The serial number is located on the rear of the unit. Retain this Owner's Manual in a safe place for future reference.

WARNING

TO REDUCE THE RISK OF FIRE OR ELECTRIC SHOCK, DO NOT EXPOSE THIS APPLIANCE TO RAIN OR MOISTURE.

CAUTION (FOR CANADA MODEL)

TO PREVENT ELECTRIC SHOCK, MATCH WIDE BLADE OF PLUG TO WIDE SLOT AND FULLY INSERT.

FOR CANADIAN CUSTOMER

THIS DIGITAL APPARATUS DOES NOT EXCEED THE "CLASS B" LIMITS FOR RADIO NOISE EMISSIONS FROM DIGITAL APPARATUS SET OUT IN THE RADIO INTERFERENCE REGULATION OF THE CANADIAN DEPARTMENT OF COMMUNICATIONS.

For U.K. customers

If the socket outlets in the home are not suitable for the plug supplied with this appliance, it should be cut off and an appropriate 3 pin plug fitted. For details, refer to the instructions described below.

Note: The plug severed from the mains lead must be destroyed, as a plug with bared flexible cord is hazardous if engaged in a live socket outlet.

Special Instructions for U.K. Model

IMPORTANT

THE WIRES IN THE MAINS LEAD ARE COLOURED IN ACCORDANCE WITH THE FOLLOWING CODE:

Blue: NEUTRAL
Brown: LIVE

The colours of the wires in the mains lead of this apparatus may not correspond with the coloured markings identifying the terminals in your plug. Proceed as follows: the wire which is coloured BLUE must be connected to the terminal which is marked with the letter N or coloured BLACK. The wire which is coloured BROWN must be connected to the terminal which is marked with the letter L or coloured RED. Making sure that neither core is connected to the earth terminal of the three pin plug.

FREQUENCY STEP switch (General Model only)

Because the interstation frequency spacing differs in different areas, set the FREQUENCY STEP switch (located at the rear) according to the frequency spacing in your area. Before setting this switch, disconnect the AC power plug of this unit from the AC outlet.

The apparatus is not disconnected from the AC power source as long as it is connected to the wall outlet, even if the apparatus itself is turned off.

CONNECTIONS

ANTENNA CONNECTIONS

- Each antenna should be connected to the designated terminals correctly, referring to the following figure.
- Both AM and FM indoor antennas are included with this unit. In general, these antennas will probably provide sufficient signal strength. Nevertheless, a properly installed outdoor antenna will give clearer reception than an indoor one. If you experience poor reception quality, an outdoor antenna may result in improvement.

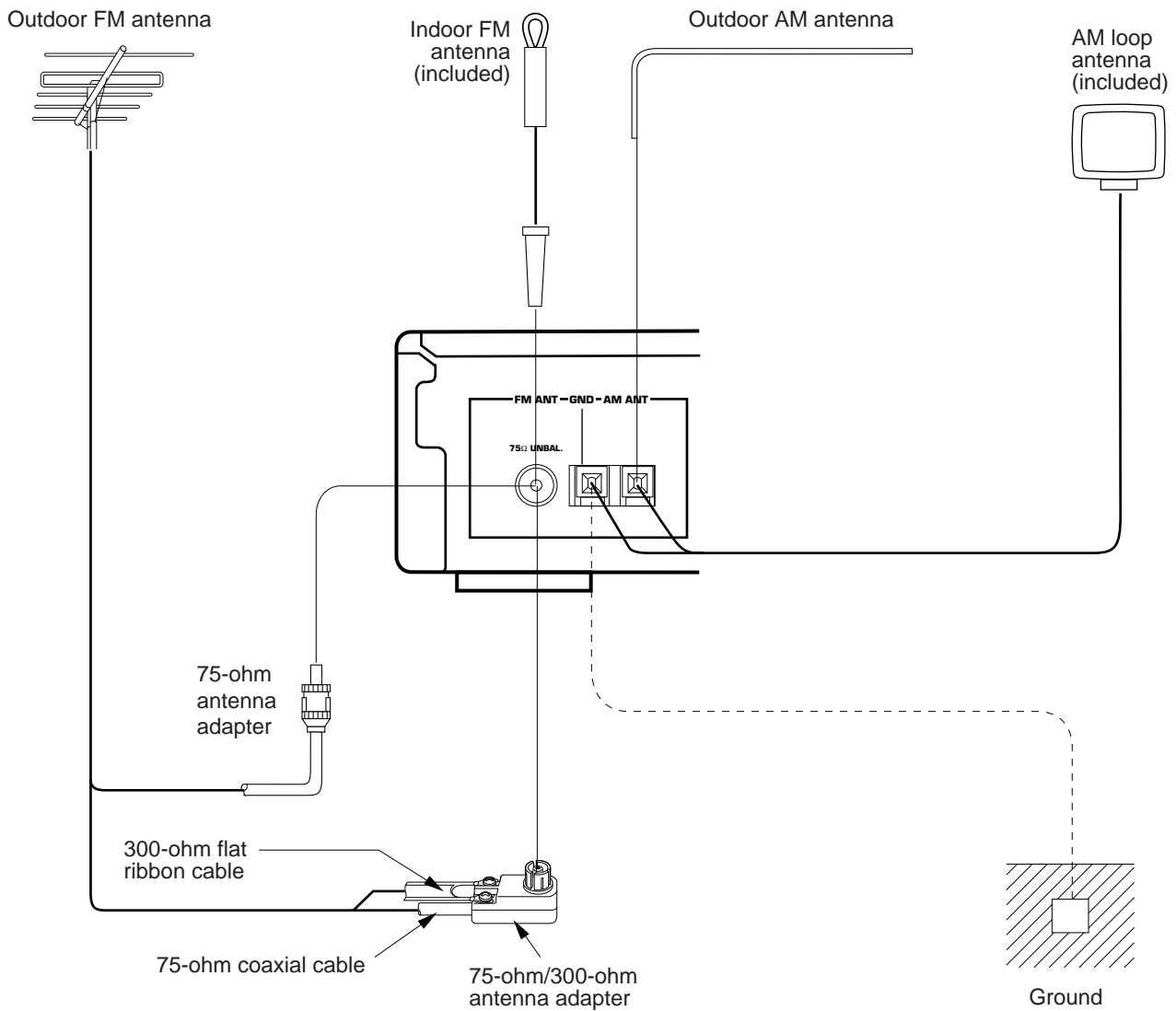

Connecting the indoor FM antenna

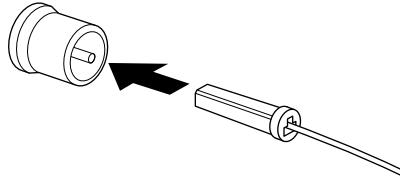

*If you connect an outdoor FM antenna to this unit, do not connect the indoor FM antenna to this unit.

Connecting the AM loop antenna

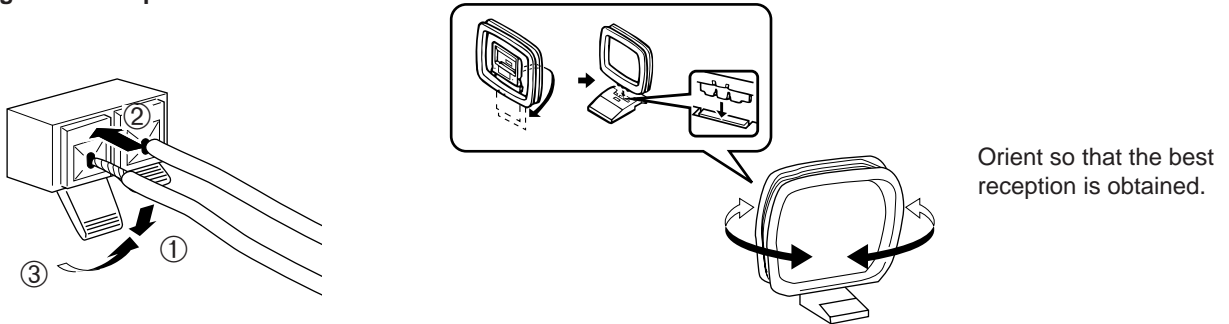

- * The AM loop antenna should be placed apart from the main unit. The antenna may be hung on a wall.
- * The AM loop antenna should be kept connected, even if an outdoor AM antenna is connected to this unit.

Optional outdoor FM antenna

Consult with your dealer or authorized service center about the best method of selecting and erecting an outdoor FM antenna. The choice of the feeder cable is also important. Flat ribbon-shaped twin-lead cable performs well electrically, and is cheaper and somewhat easier to handle when routing it through windows and around rooms. Coaxial cable is more expensive, does a much better job of minimizing interference, is less prone to the effects of weather and close-by metal objects, and is nearly as good a signal conductor as feeder cable, particularly for foam-type coaxial cables. Coaxial cable is somewhat more difficult to install at the point where the cable enters the building. If coaxial cable is selected, make sure the antenna is designed to be used with that type of cable.

* Use a 75-ohm/300-ohm antenna adapter (not included) or a 75-ohm antenna adapter (not included) for connections.

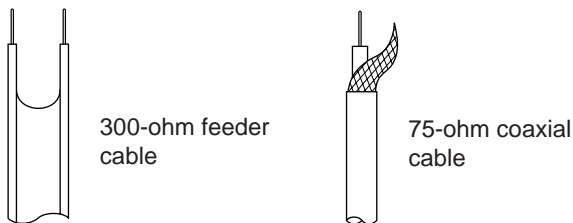
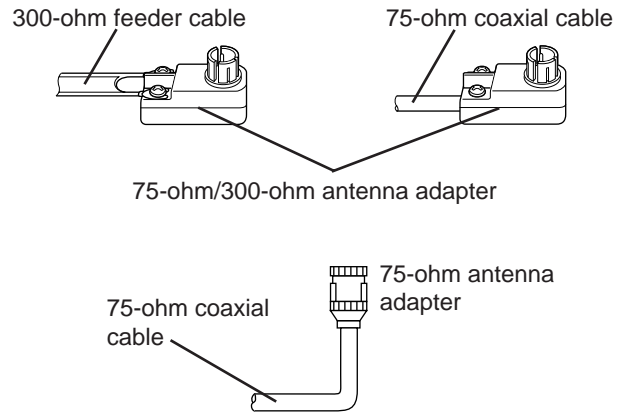

Notes for FM antenna installation

- To minimize automobile ignition noise, locate the antenna as far from heavy traffic as possible.
- Keep the feeder cable or coaxial cable as short as possible. Do not bundle or roll up excess cable.
- The antenna should be at least two meters (6.6 feet) from reinforced concrete walls or metal structures.

■ Optional outdoor AM antenna

In steel buildings or at a great distance from the transmitter, it may be necessary to install an outside long wire antenna.

GND terminal

For maximum safety and minimum interference, connect the **GND** terminal to a good earth ground. A good earth ground is a metal stake driven into moist earth.

CONNECTIONS TO THE AMPLIFIER

- Before making any connections, switch OFF the power to this unit and the amplifier or other component.
- Be sure that the connections from the left ("L") and right ("R") LINE OUT terminals are connected to the corresponding (left and right) input terminals of the amplifier or other component.
 - * When connecting with the YAMAHA amplifier AX-10, connect this unit's LINE OUT terminals to the TUNER terminals (numbered 2) on the rear of AX-10.

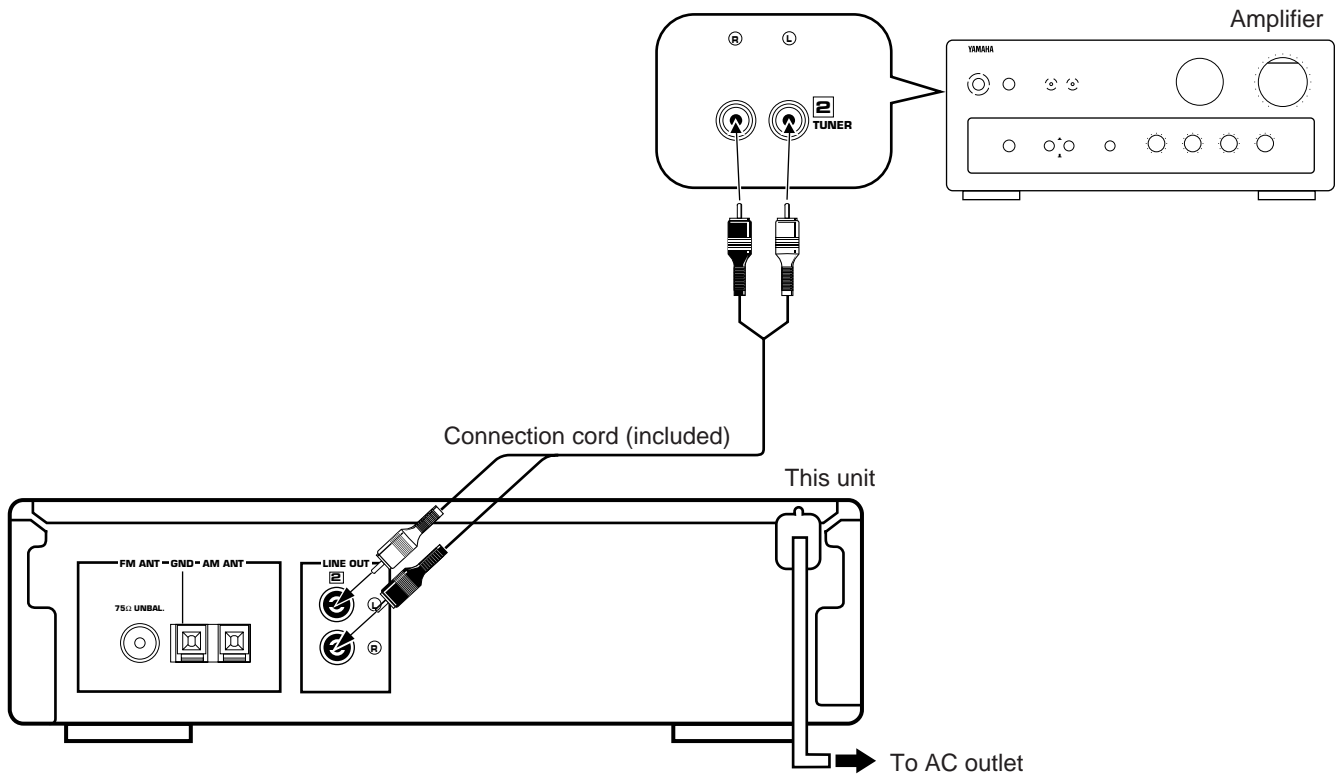

* This unit has a remote control sensor. It receives signals from the remote control transmitter provided with a YAMAHA amplifier.

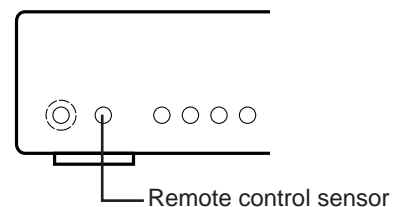

TUNING OPERATIONS

Normally, if station signals are strong and there is no interference, quick automatic-search tuning (AUTOMATIC TUNING) is possible. However, if signals of the station you want to select are weak, you must tune to it manually (MANUAL TUNING).

AUTOMATIC TUNING

<U.K. and Europe models>

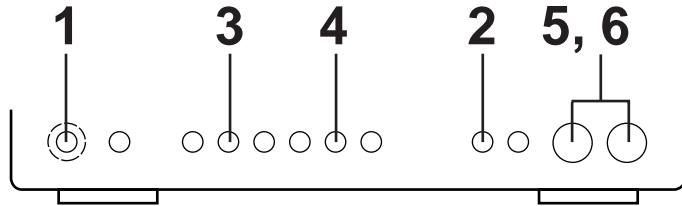

<General model>

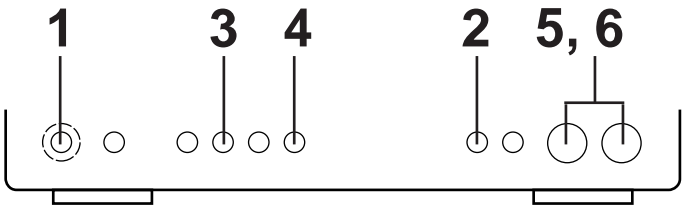

1 **STANDBY/ON**

2 Select the reception band while watching the display.

FM/AM

3 **TUNING MODE**

4 If "PRESET" is being illuminated on the display, press the **KEY MODE** button to turn it off.

<U.K. and Europe models>

<General model>

KEY MODE

5 Tune to a desired station.

PRESET STATIONS

DOWN UP

— TUNING —

To tune to a higher frequency, press the **UP** button once. To tune to a lower frequency, press the **DOWN** button once.

6 If the station where tuning search stopped is not the desired one, press again.

PRESET STATIONS

DOWN UP

— TUNING —

* If the tuning search does not stop at the desired station (because the signals of the station are weak), change to the **MANUAL TUNING** method as described on the following page.

To turn off the power
Press the **POWER** switch again.

MANUAL TUNING

<U.K. and Europe models>

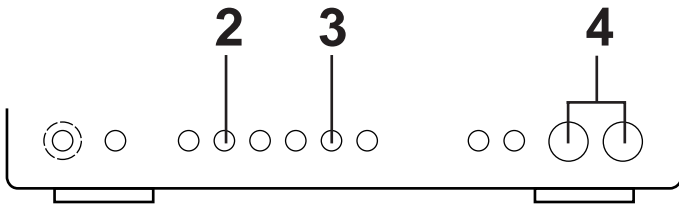

<General model>

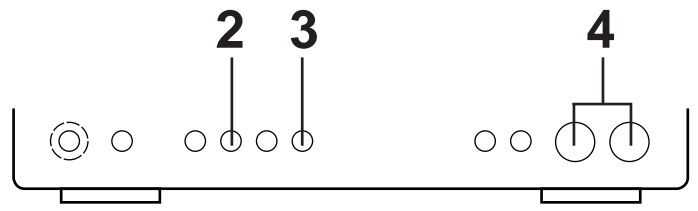

1 Follow steps 1 and 2 on the previous page.

2 **TUNING MODE**
 → "AUTO" goes off.

3 If "PRESET" is being illuminated on the display, press the **KEY MODE** button to turn it off.

<U.K. and Europe models>

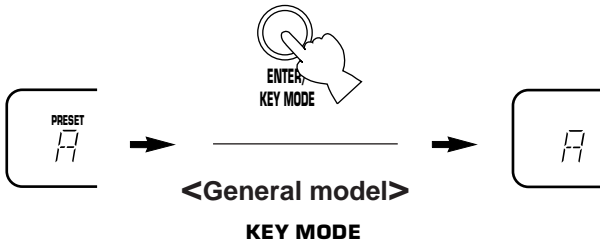

4 Tune to a desired station manually.

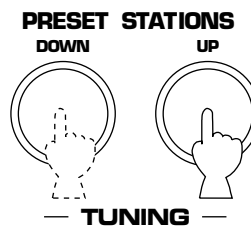

* To continue tuning search, press and hold the button.

Note

If you tune to an FM station manually, it is received in monaural mode automatically to increase the signal quality.

Display information

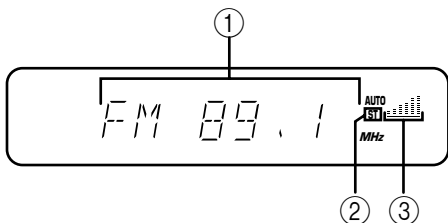

① Displays the band and frequency of the received station.

* <U.K. and Europe models only>

If an RDS station is received, the frequency is then replaced by the station name. (However, if the PS data cannot be received within 5 seconds, "NO PS" flashes, and then it returns to the frequency display.) Refer to page 13 for details.

② Illuminates when an FM stereo broadcast is received in stereo.

③ Indicates the signal level of the received station.

PRESET TUNING

MANUAL PRESET TUNING

This unit can store station frequencies selected by tuning operation. With this function, you can recall any desired station by only selecting the preset station number where it is stored. Up to 40 stations (8 stations x 5 pages) can be stored.

<U.K. and Europe models>

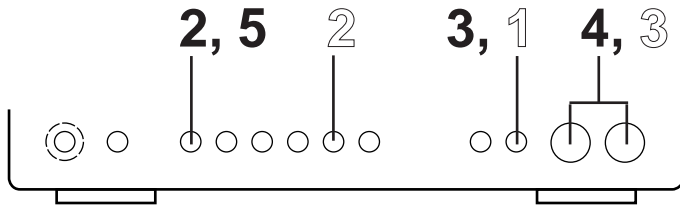

<General model>

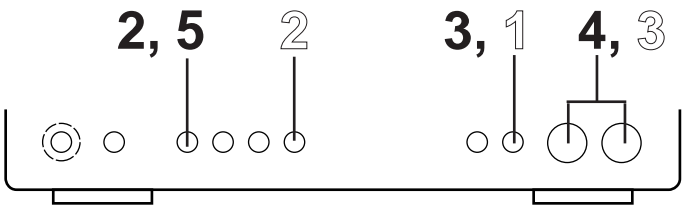

To store stations

- 1** Tune to a desired station.
(Refer to the previous page for tuning procedures.)
- 2** **MEMORY**

Flashes on and off for about 5 seconds.
- 3** Select a desired page (A – E) of preset stations while watching the display before “MEMO” goes off from the display.

A/B/C/D/E
- 4** Select a preset station number (1–8) while watching the display before “MEMO” goes off from the display.

PRESET STATIONS
DOWN UP

TUNING
- 5** **MEMORY**

Shows the displayed station has been programmed to A1.

* In the same way, program other stations to A2, A3 ... A8.
* You can program more stations on other pages in the same way by selecting other pages in step 3.

To recall a preset station

- 1** Select the page where the preset station is stored.

A/B/C/D/E
- 2** If “PRESET” is not being illuminated on the display, any preset station cannot be recalled. If so, press the **KEY MODE** button to turn it on.

<U.K. and Europe models>

<General model>
KEY MODE
- 3** **PRESET STATIONS**
DOWN UP

TUNING

Select the preset station number.

Notes

- A new setting can be programmed in place of the former one.
- For presets, the setting of the reception mode (stereo or monaural) is stored along with the station frequency.

AUTOMATIC PRESET TUNING

You can also make use of an automatic preset tuning function for FM stations only. By this function, this unit performs automatic tuning and stores FM stations with strong signals sequentially. Up to 40 stations are stored automatically in the same way as in the manual preset tuning method on page 9.

<U.K. and Europe models only>

* Only RDS stations can be stored by this function.

<U.K. and Europe models>

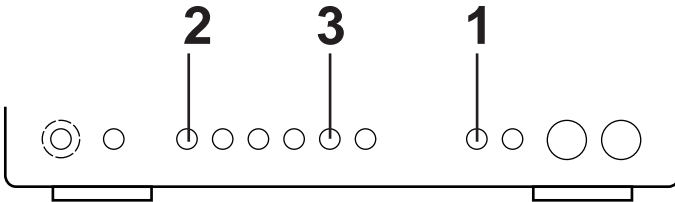

<General model>

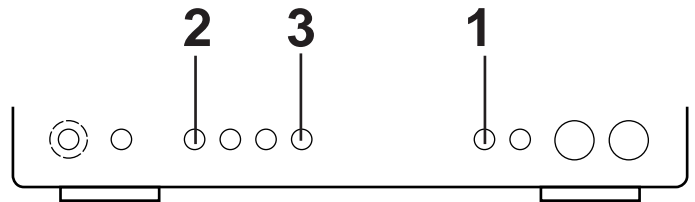

To store stations

1 **FM/AM**

2 **MEMORY**

Press and hold for about 3 seconds. Flashes.

3 **<U.K. and Europe models>** **<General model>**

ENTER KEY MODE **KEY MODE**

The automatic preset tuning begins from the frequency currently displayed. Received stations are programmed to A1, A2 ... A8 sequentially.

* If more than 8 stations are received, they are also programmed to the preset station numbers on other pages (B, C, D and E) in that order.

When the automatic preset tuning is finished

The display shows the frequency of the last preset station. Check the contents and the number of preset stations by following the procedure of the section "To recall a preset station" on page 9.

To recall a preset station

Simply follow the procedure of the section "To recall a preset station" on page 9.

<U.K. and Europe models only>

* A recalled station is shown by the frequency or station name on the display.

Notes

- You can replace a preset station by another FM or AM station manually by simply following the procedure of the section "To store stations" on page 9.
- <General model only>**
 - If the number of received stations is not enough to be stored up to E8, the search is finished automatically when it reaches the highest frequency after searching through all frequencies.
 - With this function, only FM stations with sufficient signal strength are stored automatically. If the station you want to program is weak in signal strength, tune to it in monaural manually and program it by following the procedure of the section "To store stations" on page 9.

<U.K. and Europe models only>

- The automatic preset tuning search will be performed through all RDS network frequencies until stations are stored up to E8. If the number of received stations is not enough to be stored up to E8, the search is finished automatically after searching through all frequencies.
- With this function, only RDS stations with sufficient signal strength are stored automatically. If the station you want to program is weak in signal strength, tune to it in monaural manually and program it by following the procedure of the section "To store stations" on page 9.

* There may be a case that this function cannot receive a station which could be received by the automatic tuning method. This is because this function receives a large volume of PI (Program Identification) data along with the station.

If you want to store the first station received by the automatic preset tuning to a desired preset station number.

If, for example, you want to store the first received station to C5, select "C5" by using the **A/B/C/D/E** button and the **PRESET STATIONS DOWN/UP** buttons after pressing the **MEMORY** button in step 2. Then press the **ENTER** button. The first received station is stored to C5, and next stations to C6, C7 ... sequentially.

If stations are stored up to E8, the automatic preset tuning is finished automatically.

EXCHANGING PRESET STATIONS

You can exchange the places of two preset stations with each other as shown below.

<U.K. and Europe models>

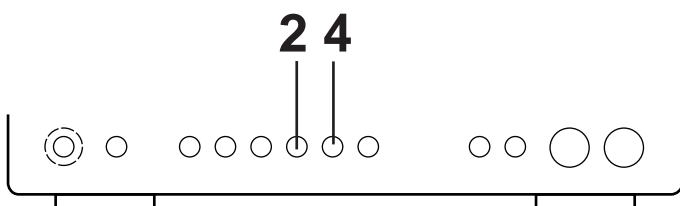

<General model>

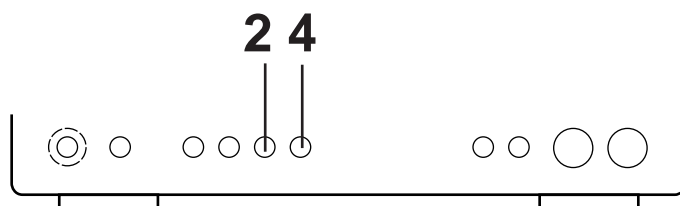



Example)

If you want to shift the preset station on E1 to A5, and vice versa.

1 Recall the preset station on E1 (by following the method of "To recall a preset station" on page 9).

2

<p><U.K. and Europe models only></p> <p>—PS/PTY/SEEK—</p>  <p>Press and hold for about 3 seconds.</p>	<p><General model only></p> <p>EDIT</p> 
--	--

↓

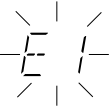

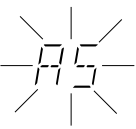

Flashes

3 Next, recall the preset station on A5 by following the same method with step 1.



Flashes

4

<p><U.K. and Europe models only></p>  <p>ENTER/KEY MODE</p>	<p><General model only></p> <p>KEY MODE</p>  <p>ENTER</p>
--	--

↓

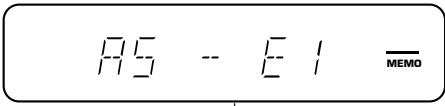

Shows the exchange of stations is completed.

Memory back-up

The memory back-up circuit prevents the programmed data from being lost even if the **POWER** switch is set off or the power plug is disconnected from the AC outlet or the power is cut due to temporary power failure. If, however, the power is cut for more than one week, the memory may be erased. If so, it can be re-programmed by simply following the PRESET TUNING steps.

RECEIVING RDS STATIONS (U.K. and Europe models only)

RDS (Radio Data System) is a data transmission system gradually being introduced by FM stations in many countries. Stations using this system transmit an inaudible stream of data in addition to the normal radio signal.

RDS data contains various information, such as AF (Alternative Frequencies for the same program station), PI (Program Identification), PS (Program Service station name), PTY (Program Type name), etc.

RDS function is carried out among the network stations.

* This unit utilizes AF, PI, PS and PTY to receive RDS broadcast stations.

Displaying RDS data

This unit can be turned into the following two modes to display RDS data.

PS (Program Service station name) mode:

Displays the name of the RDS station now being received instead of the frequency.

BBC R3

PTY (Program Type name) mode:

Displays the program type of the RDS station now being received. There are 15 program types to classify RDS stations as follows.

NEWS	News: Short accounts of facts, events and publicly expressed views, reportage and actuality.	VARIED	Varied: Used for mainly speech-based programs usually of light-entertainment nature, not covered by above categories. Examples are: quizzes, panel games, personality interviews, comedy and satire.
AFFAIRS	Current affairs: Topical program expanding or enlarging upon the news, generally in different presentation style or concept, including documentary debate, or analysis	POP M	Pop: Commercial music, which would generally be considered to be of current popular appeal, often featuring in current or recent record sales charts.
INFO	Information: Program whose purpose is to impart advice in the widest sense, including meteorological reports and forecasts, consumer affairs, medical help, etc.	ROCK M	Rock: Contemporary modern music, usually written and performed by young musicians.
SPORT	Sport: Program concerned with any aspect of sport.	MOR M	M.O.R.: (Middle of the Road Music). Common term to describe music considered to be "easy-listening", as opposed to Pop, Rock or Classical. Music in this category is often but not always, vocal, and usually of short duration (<5 min.)
EDUCATE	Education: Program intended primarily to educate, of which the formal element is fundamental.	LIGHT M	Light classics: Classical Musical for general, rather than specialist appreciation. Examples of music in this category are instrumental music, and vocal or choral works.
DRAMA	Drama: All radio plays and serials.	CLASSICS	Serious classics: Performances of major orchestral works, symphonies, chamber music etc., and including Grand Opera.
CULTURE	Culture: Programs concerned with any aspect of national or regional culture, including religious affairs, philosophy, social science, language, theatre, etc.	OTHER M	Other music: Musical styles not fitting into any of the above categories. Particularly used for specialist music, of which Jazz, Rhythm & Blues, Folk, Country, and Reggae are examples.
SCIENCE	Science: Programs about the natural sciences and technology.		

To turn the unit into the PS mode or PTY mode

Press the **FREQ/PS/PTY** button. Whenever pressed, the mode changes into the PS mode, PTY mode and returns to usual mode in turn.

* When an RDS station is received, the display is automatically turned into the PS mode. Do not press the **FREQ/PS/PTY** button until the display is turned into the PS mode. If the button is pressed before the display mode is changed, it may occur that "NO PS" flashes on the display. This is because the unit has not received all of the RDS data on the station yet.

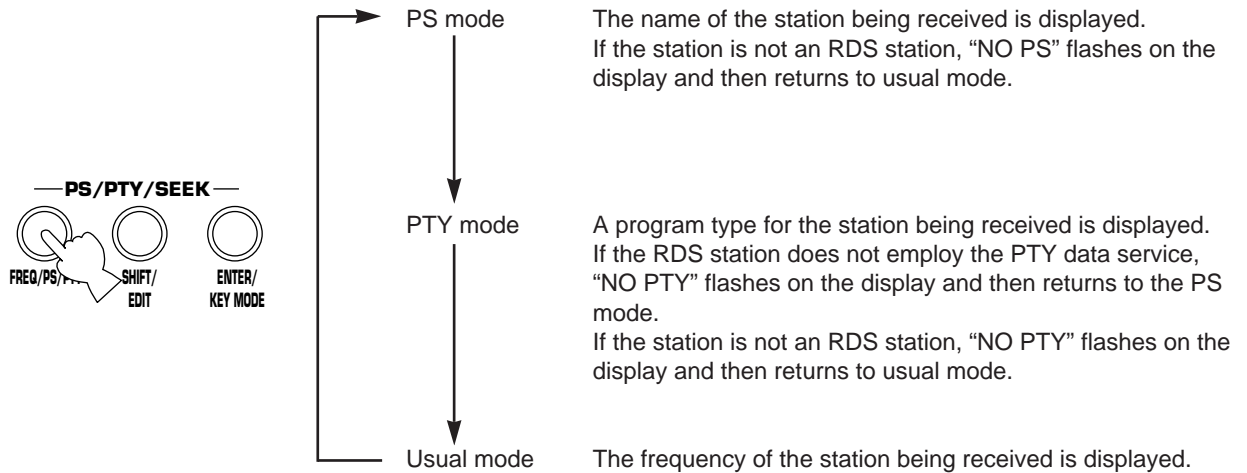

Note

When PS or PTY data reception is not possible due to poor reception conditions, "NO PS" or "NO PTY" flashes on the display in each mode. In such a case, press the **TUNING MODE** button so that "AUTO" goes off from the display. Though the reception mode is changed to monaural by this operation, when you changes to the PS or PTY mode, PS or PTY data may be displayed.

Calling a preset RDS station by the station name (PS SEEK)

You can call a desired RDS station stored in this unit by only inputting the name of the station in the PS mode. By this operation, this unit searches all preset stations for the station. You do not have to input a full name, even only the first letter can be used for calling. As many as 8 letters and/or numerals can be selected for inputting a name.

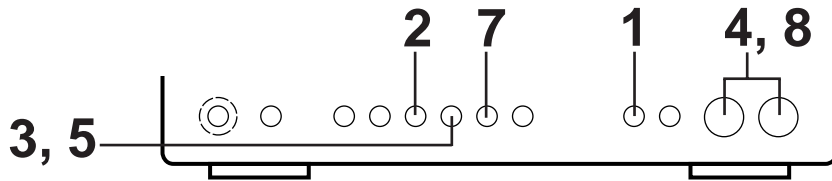

1 **FM/AM**

2 Turn the unit into the PS mode.

— PS/PTY/SEEK —

A station name is displayed or "NO PS" flashes.

* If "NO PS" flashes, proceed to the next step while flashing. If "NO PS" disappears before you proceed to the next step, press the **FREQ/PS/PTY** button again.

3 — PS/PTY/SEEK —

Flashes

4 Select the first letter or numeral of the station name.

PRESET STATIONS
DOWN UP

— TUNING —

- * By pressing the **TUNING UP** or **DOWN** button repeatedly or by pressing and holding either of them, the display will change letters and numerals in sequence.
- * If you will not input the second letter, skip to step 7.

5 When the first letter or numeral of the station name appears, press the **SHIFT/EDIT** button to proceed to the selection of the next letter or numeral.

— PS/PTY/SEEK —

"A" will flash on the second letter or numeral position.

6 Repeat steps 4 and 5 for other letters and/or numerals, if necessary.

7 When inputting the name is finished, press the **ENTER/KEY MODE** button.

— PS/PTY/SEEK —

The name is illuminated.

8

PRESET STATIONS
DOWN UP

— TUNING —

Press once.

The unit begins searching for the station, and it is continued until the station is found.

You do not have to input a full name for searching for the station

You may input only the first letter of the station name. If doing so, you can skip steps 5 and 6. In step 8, the unit searches for and calls a nearest station which has the letter you input. If the station is not the desired one, press the **TUNING UP** or **DOWN** button again. The unit will begin searching for another station which has the same letter.

To cancel this function

Press the **AF**, **FREQ/PS/PTY**, **SHIFT/EDIT**, **ENTER/KEY MODE**, **FM/AM** or **MEMORY** button.

Note

This function is not useful for calling a station with weak signals which cannot be received by the automatic tuning method.

Calling a preset RDS station by the program type (PTY SEEK)

By designating a program type, the unit automatically searches all preset stations for RDS stations of that program type.
 * There are 15 program types to classify RDS stations. For details, refer to page 12.

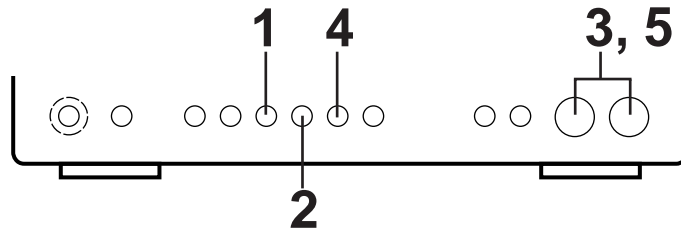

1 Turn the unit into the PTY mode.

—PS/PTY/SEEK—

FREQ/PS/PTY SHIFT/EDIT ENTER/KEY MODE

→

Press once or twice until a program type is displayed or “NO PTY” flashes.

* If “NO PTY” flashes, proceed to the next step while flashing. If “NO PTY” disappears before you proceed to the next step, press the **FREQ/PS/PTY** button once or twice.

2

—PS/PTY/SEEK—

FREQ/PS/PTY SHIFT/EDIT ENTER/KEY MODE

→

NEWS

The program type of the station now being received or “NEWS” flashes on the display.

3 Select the desired program type.

PRESET STATIONS

DOWN UP

— TUNING —

* By pressing the **TUNING UP** or **DOWN** button repeatedly or by pressing and holding either of them, the display will change program types in sequence.

4 When the desired program type appears, press the **ENTER/KEY MODE** button.

—PS/PTY/SEEK—

FREQ/PS/PTY SHIFT/EDIT ENTER/KEY MODE

→

POP M

ENTER

Flashes.

5

PRESET STATIONS

DOWN UP

— TUNING —

Press once.

The unit begins searching all preset stations, and calls a station of the program type if such a station is found.

* When the **TUNING UP** button is pressed, the search is performed from “A1” toward higher numbers of the preset stations (A1, A2 ... A8, B1, B2, ...). If, however, “A3” is currently being called for example, the search begins from the next station “A4”.

When the **TUNING DOWN** button is pressed, the search is performed in reverse order.

If the called station is not the desired one, press the **TUNING UP** or **DOWN** button again to search for another station of the same program type.

To cancel this function
 Press the **AF**, **FREQ/PS/PTY**, **SHIFT/EDIT**, **ENTER/KEY MODE**, **FM/AM** or **MEMORY** button.

Calling the best quality RDS station which broadcasts the same program (AF SEEK)

This function automatically searches for and calls another RDS station of the best reception quality which broadcasts the same program now you are listening to.

This function utilizes AF (Alternative Frequencies for the same program station) and PI (Program Identification) of RDS data service. The search is carried out among the RDS network stations.

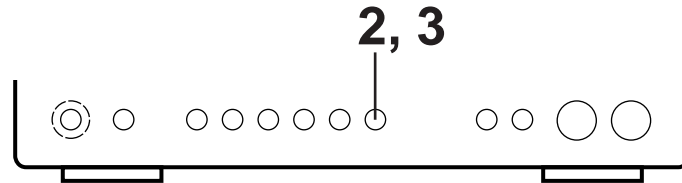

- 1** Tune to a desired RDS station.
 * Wait for about 10 seconds before proceeding to the next step. This allows the unit to search for more stations.

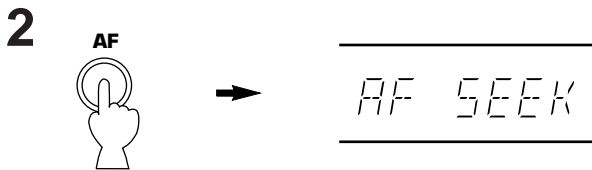

The unit searches for other stations with the same program.

- * If the station is not an RDS station, or there is no other station with the same program, "NO AF" flashes.



Stations with the same program are all stored and numbered from the best quality station in sequence.

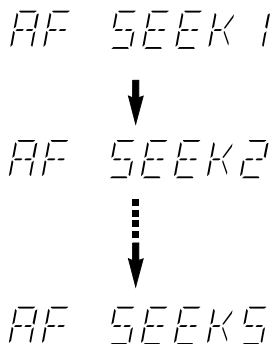

When the search is finished, the best quality station is called.

- 3** If desired, you can call the second station by pressing the **AF** button.



Whenever the **AF** button is pressed, stored stations are called in sequence.

When pressed after the last station is selected, the first one is restored.

To cancel this function

Press a button other than the **AF** button.
 All of the stored stations will be also cleared.

TROUBLESHOOTING

If the unit fails to operate normally, check the following points to determine whether the fault can be corrected by the simple measures suggested. If it cannot be corrected, or if the fault is not listed in the SYMPTOM column, disconnect the power cord and contact your authorized YAMAHA dealer or service center for help.

	SYMPTOM	CAUSE	REMEDY
FM	Crackling sounds from time to time (especially in weak signal areas).	Ignition noise from passing vehicles.	The FM antenna should be put up as high as possible, away from the road, and a coaxial cable used.
		Noise from thermostats or other electrical equipment.	Attach a noise suppressor to the equipment causing the noise.
	FM stereo reception is noisy.	Because of the characteristics of FM stereo broadcasts, this is limited to cases where the transmitter is far away or the antenna input is poor.	Check the antenna connections. Try using a high quality directional FM antenna. Set the TUNING MODE button to the manual tuning mode.
	The "ST" indicator flickers and reception is noisy.	Insufficient antenna input.	Use an antenna appropriate for the reception condition in your area.
		Not tuned correctly.	Tune again.
	There is distortion and clear reception cannot be obtained even with a good FM antenna.	There is multipath interference.	Adjust antenna placement to eliminate multipath interference.
	No stereo effect even with a stereo broadcast.	The TUNING MODE button is set to the manual tuning mode.	Set the button properly.
	A desired station cannot be tuned in with Automatic tuning.	The station is too weak.	Use the manual tuning mode. Use a high quality directional FM antenna.
Previously preset stations can no longer be tuned in.	The tuner has been unplugged for a long period.	Repeat the presetting procedure.	
AM	Insufficient sensitivity.	Weak signal or loose antenna connections.	Tighten the AM loop antenna connections and rotate it for best reception.
	A desired station cannot be tuned in with Automatic tuning.		Use the manual tuning mode.
	There are continuous crackling and hissing noises.	These noises result from lightning, fluorescent lamps, motors, thermostats and other electrical equipment.	Use an outdoor antenna and a ground wire. This will help somewhat but it is difficult to eliminate all noises.
	There are buzzing and whining noises (especially in the evening).	Another station is interfering with the received station.	This is impossible to remedy.
A television set is being used nearby.		Relocate this unit away from the TV.	

SPECIFICATIONS

FM SECTION

Tuning Range	87.5 to 108 MHz
50 dB Quieting Sensitivity (IHF) [Except Europe model]	
75 ohms Mono	1.55 μ V (15.1 dBf)
75 ohms Stereo	21 μ V (37.7 dBf)
Usable Sensitivity [Europe model] (DIN)	
75 ohms Mono (S/N 26 dB)	0.9 μ V
75 ohms Stereo (S/N 46 dB)	24 μ V
Image Response Ratio	
[Except Europe model]	45 dB
[Europe model]	80 dB
IF Response Ratio	
[Except Europe model]	70 dB
[Europe model]	80 dB
Spurious Response Ratio	70 dB
AM Suppression Ratio	55 dB
Capture Ratio	1.5 dB
Alternate Channel Selectivity	
[Except Europe model]	85 dB
Selectivity (two signals, 40 kHz Dev., \pm 300 kHz)	
[Europe model only]	70 dB
Signal-to-Noise Ratio	
[Except Europe model] (IHF)	
Mono	80 dB
Stereo	75 dB
[Europe model] (DIN-Unweighted)	
Mono (40 kHz Dev.)	74 dB
Stereo (40 kHz Dev.)	69 dB
Harmonic Distortion (1 kHz)	
[Except Europe model]	
Mono/Stereo	0.1%/0.2%
[Europe model (40 kHz Dev.)]	
Mono/Stereo	0.1%/0.2%
Stereo Separation (1 kHz)	
[Except Europe model]	50 dB
[Europe model (40 kHz Dev.)]	50 dB
Frequency Response	
30 Hz to 15 kHz	0 \pm 0.5 dB

AM SECTION

Tuning Range	
[General model]	530 to 1,710 kHz
[U.K. and Europe models]	531 to 1,611 kHz
Usable Sensitivity	100 μ V/m
Selectivity	32 dB
Signal-to-Noise Ratio	50 dB
Image Response Ratio	40 dB
Spurious Response Ratio	50 dB
Harmonic Distortion; 400 Hz	0.3%

AUDIO SECTION

Output Level/Impedance (Fixed)	
FM (100 % mod. 1 kHz)	
[Except Europe model]	550 mV/2.2 k-ohms
[Europe model (40 kHz Dev.)]	400 mV/2.2 k-ohms
AM (30% mod. 400 Hz)	150 mV/2.2 k-ohms

GENERAL

Power Supply	
[Europe model]	230V, 50 Hz
[U.K. model]	240V, 50 Hz
[General model]	110-120/220-240V, 50/60 Hz
Power Consumption	
[Except General model]	10W
[General model]	7W
Dimensions (W x H x D)	280 x 82.5 x 360 mm (11" x 3-1/4" x 14-3/16")
Weight	3 kg (6 lbs. 10 oz.)
Accessories	Audio connection cord AM loop antenna Indoor FM antenna

* Specifications subject to change without notice.

YAMAHA

YAMAHA ELECTRONICS CORPORATION, USA 6660 ORANGETHORPE AVE., BUENA PARK, CALIF. 90620, U.S.A.
YAMAHA CANADA MUSIC LTD. 135 MILNER AVE., SCARBOROUGH, ONTARIO M1S 3R1, CANADA
YAMAHA ELECTRONIK EUROPA G.m.b.H. SIEMENSSTR. 22-34, D-2084 RELINGEN BEI HAMBURG, F.R. OF GERMANY
YAMAHA ELECTRONIQUE FRANCE S.A. 17 RUE DES CAMPANULES, LOGNES 77321 MARNE LA VALLEE CEDEX 2, FRANCE
YAMAHA ELECTRONICS (UK) LTD. YAMAHA HOUSE, 200 RICKMANSWORTH ROAD WATFORD, HERTS WD1 7JS, ENGLAND
YAMAHA SCANDINAVIA A.B. J A WETTERGRENS GATA 1, BOX 30053, 400 43 VÄSTRA FRÖLUNDA, SWEDEN
YAMAHA MUSIC AUSTRALIA PTY, LTD. 17-33 MARKET ST., SOUTH MELBOURNE, 3205 VIC., AUSTRALIA

YAMAHA CORPORATION